



More information on the website  
[mirror.radwag.com/br/info,w1,5NN](http://mirror.radwag.com/br/info,w1,5NN)

# Plataforma multifuncional HY10.3.H1.K

WP-116-0011



The drawings, photos and graphics used are for illustrative purposes only.

## Funções

-  Dosing
-  Labelling
-  Plus/Minus Control
-  Percent Weighing
-  Totalizing
-  Parts counting
-  Peak hold
-  Formulation
-  Newton unit measurement
-  Statistics
-  Checkweighing
-  GLP Procedures
-  Animal weighing
-  Differential weighing
-  Replaceable unit
-  Statistical Quality Control
-  ALIBI Memory
-  Transactions

## Ficha Técnica

### Parâmetros metrológicos

Capacidade máxima [máx]	3 kg
Carga mínima	20 g
Resolução [d]	1 g
Unidade de verificação [e]	1 g

Parâmetros metrológicos	
Faixa de tara	-3 kg
Resolução máxima para plataforma não verificada	0,2 g
Ajuste	externa
Classe OIML	III
Parâmetros físicos	
Display	10,1" gráfico colorida tela touchscreen
Comprimento até cabo	1,5 m
Dimensões até prato de pesagem	150x200 mm
Dimensões da embalagem L x P x A	350x420x470 mm
Peso líquido	8,48 kg
Peso bruto	10 kg
Construção	
Classe de proteção	IP 66 / 67 construção, IP 66 / 67 / 69 terminal
Interface de comunicação	
Interface de comunicação	2xRS232, 2xUSB-A, Ethernet, 4 IN / 4 OUT (digital)
Interfaces opcionais	módulo Wi-Fi 802.11 b/g/n, módulo Profibus (DP SLAVE), módulo RS485, módulo PROFINET (RJ45), módulo de saída analógica (4-20mA, 0-20mA, 0-10V) , 12IN / 12OUT (IN – 5-24 VDC, OUT – max 30 VDC, 0,5 ADC)
Parâmetros elétricos	
Fonte de alimentação	100 – 240 V AC 50/60 Hz
Condições ambientais	
Temperatura de operação	-10 – +40 °C
Umidade relativa	10% – 85% RH sem condensação

\* Wi-Fi® is a registered trademark of Wi-Fi® Alliance.



Additional fee for verification



## Acessórios (Additional Fee)

Unidade de loop de corrente AP2-4  
Mesas antivibração  
Cabos de rede (plataforma - Ethernet)  
Displays  
Cabos IN/OUT  
Leitores de código de barras

Impressoras de etiquetas  
Teclado, interruptores externos  
Impressora de recibos  
Pesos padrão F1 -  
pesos botão sem câmara de ajuste, conjuntos  
RS 232 – Conversor USB

## Software (Additional Fee)

- E2R Pesagem [WX-010-0099]
- Leitor Audit Trail [WX-010-0186]
- RADWAG Remote Desktop [WX-010-0107]
- RADWAG Development Studio [WX-010-0104]

- RAD Key [WX-010-0005]
- Editor de etiquetas R02 [WX-010-0094]
- R-Lab [WX-010-0080]

# Dimensões do dispositivo L x P x A



H Platform

Scale type	A1	A2	B
HY10 H1.K	200	150	85 ±3
HY10 H2.K	250	300	103 ±3
HY10 H3.K	410	410	98 ±2
HY10 H4.K	500	500	155 ±5
HY10 H5.K	600	600	155 ±5
HY10 H6.K	800	800	135 ±5

dimensions in mm

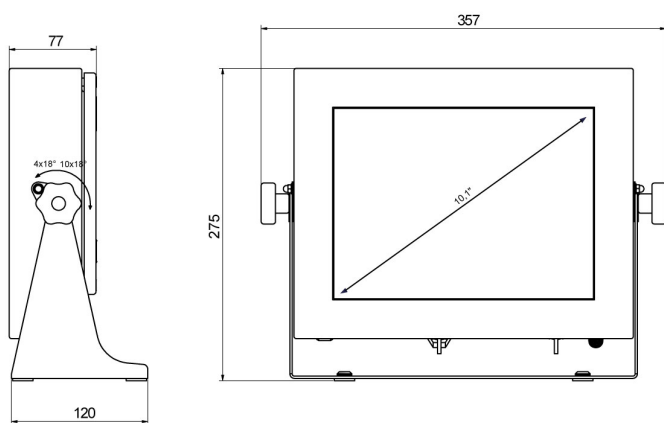

PUE HY10