



More information on the website
mirror.radwag.com/tr/info,w1,4IZ

HY10.300.HRP.H.M2.1 Yüksek Çözünürlüklü Terazî

WP-340-0021



The drawings, photos and graphics used are for illustrative purposes only.

Fonksiyonlar



Dosing



Labelling



Plus/Minus Control



Percent Weighing



Totalizing



Parts counting



Peak hold



Formulation



Newton unit
measurement



Statistics



Checkweighing



GLP Procedures



Animal weighing



Differential weighing



Replaceable unit



Statistical Quality Control



ALIBI Memory



Transactions

Teknik Veriler

Metrolojik parametreler	
Maksimum yük [Max]	300 kg
Minimum yük [Min]	50 g
Ön yük	60 kg

Metrolojik parametreler	
Okuma için ğruluđu [d]	1 g
Yasallařtırma birimi [e]	10 g
Dara aralıđı	-300 kg
Tekrarlanabilirlik	3 g
Dođrusallık	±6 g
Kararlılık süresi	3 s
Ayarlama	dahili (otomatik)
OIML sınıfı	II
Maximum quantity of verification units	30000 e
Fiziksel parametreler	
Display	10,1" grafik renkli dokunmatik
Tartım kefesi boyutları	800x600 mm
Ambalaj boyutları G x D x Y	800x1000x537 mm
Net ađırlık	71,5 kg
Brüt ađırlık	119 kg
Konstrüksiyon	
IP Sınıfı	IP 66 / 67 konstrüksiyon, IP 66 / 67 / 69 terminal
Konstrüksiyon	Paslanmaz çelik AISI304
Tartım kefesi	Paslanmaz çelik AISI304
Haberleřme arayüzler	
Haberleřme arayüzü	2xRS232, 2xUSB-A, Ethernet, 4 IN / 4 OUT (dijital)
Opsiyonel arayüzler	modül Wi-Fi 802.11 b/g/n, modül Profibus (DP SLAVE), modül RS485, modül PROFINET (RJ45), analog çıkıř modülü (4-20mA, 0-20mA, 0-10V) , 12IN / 12OUT (IN – 5-24 VDC, OUT – max 30 VDC, 0,5 ADC)
Elektrik parametreleri	
Güç kaynađı	100 – 240 V AC 50/60 Hz
Çevresel kořullar	
Çalıřtırma sıcaklıđı	+10 – +40 °C
Atmosferik nem	15% – 80%

Tekrarlanabilirlik, 10 yüklemenin standart sapması olarak ifade edilir.

Bađıl nem - yođuşmasız kořullar altında.

Stabilizasyon süresi - optimum ortam kořulları altında.

* Wi-Fi® is a registered trademark of Wi-Fi® Alliance.



Additional fee for verification



Aksesuarlar (Additional Fee)

AP2-4 Güç döngüsü çıkıřı
RS 232 Kablolar (Teraziler - Yazıcı)
Transponder kart okuyucular
RS 232 Kabloları (Teraziler - ZEBRA Yazıcı)
Ađ kabloları (Teraziler - Ethernet)

Etiket Yazıcısı
Tartım terminalleri için tutucular
Klavye
Fiř yazıcı
USB Kablolar (terazi-Epson yazıcı)

Display
RS 232, RS 485 Kabloları
Giriş/Çıkış kabloları
Barkod okuyucu

Modülleri ek platformları
Ek modüller
RS 232 – USB Dönüştürücü

Yazılım (Additional Fee)

- E2R Tartım [WX-010-0099]
- Audit Trail Reader [WX-010-0186]
- RADWAG Remote Desktop [WX-010-0107]
- Terazi Editörü - EWAG 2.1 [WX-010-0173]
- RAD Key [WX-010-0005]
- Etiket Editörü R02 [WX-010-0094]
- R-Lab [WX-010-0080]
- RADWAG Development Studio [WX-010-0104]

Cihaz boyutları G x D x Y



HY10.16 - 32.HRP.H

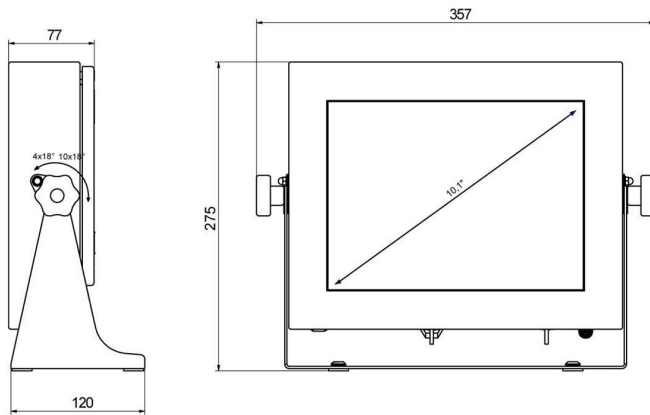

PUE HY10

Scale type	A1	A2	H
HY10.(16-32).HRP.H	360	280	180±5
HY10.(62-150).HRP.H	500	400	180±5
HY10.150.2.HRP.H	500	500	180±5
HY10.(150.1-300).HRP.H	800	600	180±5
HY10.(300.1-1100).HRP.H	1000	800	180±5
HY10.(2000).HRP.H	1250	1000	180±5

Dimensions in mm