



# HY10.6.F1.K Çok Fonksiyonlu Terazı



















WP-116-0002

More information on the website  
[mirror.radwag.com/tr/info,w1,2W9](http://mirror.radwag.com/tr/info,w1,2W9)



The drawings, photos and graphics used are for illustrative purposes only.

## Fonksiyonlar

-  Dosing
-  Labelling
-  Plus/Minus Control
-  Percent Weighing
-  Totalizing
-  Parts counting
-  Peak hold
-  Formulation
-  Newton unit measurement
-  Statistics
-  Checkweighing
-  GLP Procedures
-  Animal weighing
-  Differential weighing
-  Replaceable unit
-  Statistical Quality Control
-  ALIBI Memory
-  Transactions

## Teknik Veriler

### Metrolojik parametreler

Maksimum yük [Max]	6 kg
Minimum yük [Min]	40 g
Okuma için ğruluđu [d]	2 g
Yasallařtırma birimi [e]	2 g

Metrolojik parametreler	
Dara aralığı	-6 kg
Ticari amaçla kullanılmayan terazi için maksimum hassasiyet	0,2 g
Ayarlama	harici
OIML sınıfı	III
Fiziksel parametreler	
Display	10,1" grafik renkli dokunmatik
Kablo uzunluğu	1 m
Tartım kefesi boyutları	300×300 mm
Ambalaj boyutları G x D x Y	390×570×390 mm
Net ağırlık	10,3 kg
Brüt ağırlık	12,2 kg
Konstrüksiyon	
IP Sınıfı	IP 65 konstrüksiyon, IP 66 / 67 / 69 terminal
Haberleşme arayüzler	
Haberleşme arayüzü	2×RS232, 2×USB-A, Ethernet, 4 IN / 4 OUT (dijital)
Opsiyonel arayüzler	modül Wi-Fi 802.11 b/g/n, modül Profibus (DP SLAVE), modül RS485, modül PROFINET (RJ45), analog çıkış modülü (4-20mA, 0-20mA, 0-10V), 12IN / 12OUT (IN – 5-24 VDC, OUT – max 30 VDC, 0,5 ADC)
Elektrik parametreleri	
Güç kaynağı	100 – 240 V AC 50/60 Hz
Çevresel koşullar	
Çalıştırma sıcaklığı	-10 – +40 °C
Atmosferik nem	10% – 85% RH yoğunlaşma yok

\* Wi-Fi® is a registered trademark of Wi-Fi® Alliance.



Additional fee for verification



## Aksesuarlar (Additional Fee)

AP2-4 Güç döngüsü çıkışı  
RS 232 Kablolar (Teraziler - Yazıcı)  
Transponder kart okuyucular  
RS 232 Kabloları (Teraziler - ZEBRA Yazıcı)  
Ağ kabloları (Teraziler - Ethernet)  
Display  
RS 232, RS 485 Kabloları  
Giriş/Çıkış kabloları  
Barkod okuyucu  
Etiket Yazıcısı

Tartım terminalleri için tutucular  
Antivibrasyon masaları  
Klavye  
Fiş yazıcı  
F1 Kütle standardı - ayar odacısız silindirik ağırlıklar, setleri  
USB Kablolar (terazi-Epson yazıcı)  
Modülleri ek platformları  
Ek modüller  
RS 232 – USB Dönüştürücü

## Yazılım (Additional Fee)

- E2R Tartım [WX-010-0099]
- Audit Trail Reader [WX-010-0186]
- RADWAG Remote Desktop [WX-010-0107]

- RAD Key [WX-010-0005]
- Etiket Editörü R02 [WX-010-0094]
- R-Lab [WX-010-0080]

# Cihaz boyutları G x D x Y

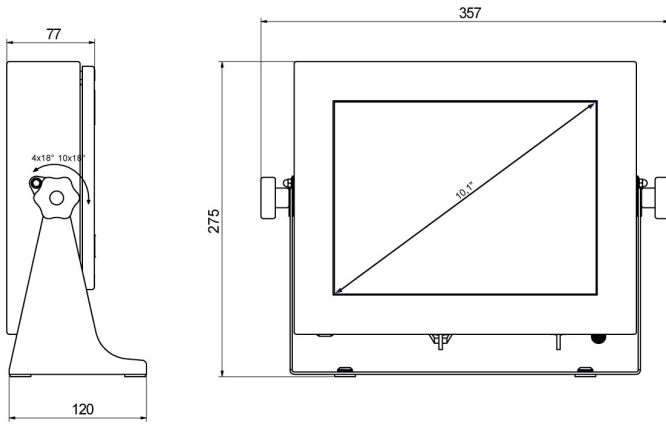
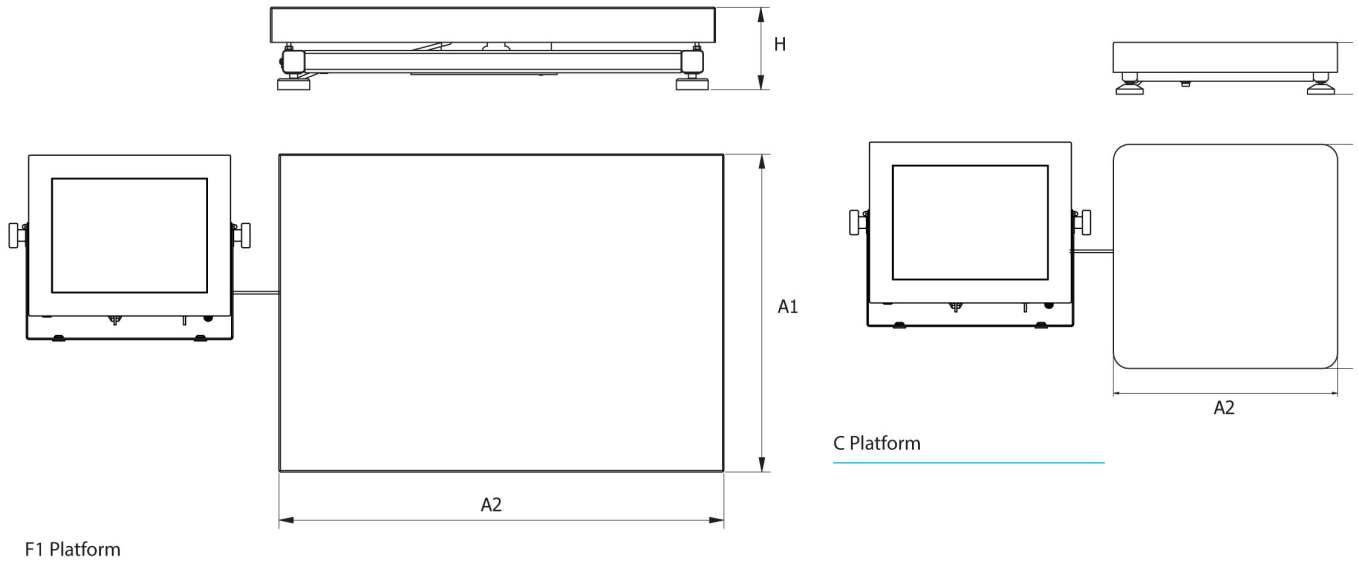

PUE HY10

Scale type	A1	A2	H
HY10.C2.K	400	500	103 ±3
HY10.C3.K	500	700	130 ±3
HY10.F1.K	300	300	70 ±3

dimensions in mm