



More information on the website  
mirror.radwag.com/tr/info,w1,2KD

# HY10.62.HRP.H.M2.2 Yüksek Çözünürlüklü Terazı

WP-340-0016



The drawings, photos and graphics used are for illustrative purposes only.

## Fonksiyonlar



Dosing



Labelling



Plus/Minus Control



Percent Weighing



Totalizing



Parts counting



Peak hold



Formulation



Newton unit measurement



Statistics



Checkweighing



GLP Procedures



Animal weighing



Differential weighing



Replaceable unit



Statistical Quality Control



ALIBI Memory



Transactions

## Teknik Veriler

Metrolojik parametreler	
Maksimum yük [Max]	62 kg
Minimum yük [Min]	100 g
Ön yük	30 kg

Metrolojik parametreler	
Okuma için ğruluđu [d]	2 g
Yasallařtırma birimi [e]	2 g
Dara aralıđı	-62 kg
Tekrarlanabilirlik	0,6 g
Dođrusallık	$\pm 2$ g
Kararlılık süresi	2 s
Ayarlama	dahili (otomatik)
OIML sınıfı	II
Maximum quantity of verification units	31000 e
Fiziksel parametreler	
Display	10,1" grafik renkli dokunmatik
Tartım kefesi boyutları	500x400 mm
Ambalaj boyutları G x D x Y	610x710x505 mm
Net ađırlık	37 kg
Brüt ađırlık	52 kg
Konstrüksiyon	
IP Sınıfı	IP 66 / 67 konstrüksiyon, IP 66 / 67 / 69 terminal
Konstrüksiyon	Paslanmaz çelik AISI304
Tartım kefesi	Paslanmaz çelik AISI304
Haberleřme arayüzler	
Haberleřme arayüzü	2xRS232, 2xUSB-A, Ethernet, 4 IN / 4 OUT (dijital)
Opsiyonel arayüzler	modül Wi-Fi 802.11 b/g/n, modül Profibus (DP SLAVE), modül RS485, modül PROFINET (RJ45), analog çıkıř modülü (4-20mA, 0-20mA, 0-10V) , 12IN / 12OUT (IN – 5-24 VDC, OUT – max 30 VDC, 0,5 ADC)
Elektrik parametreleri	
Güç kaynađı	100 – 240 V AC 50/60 Hz
Çevresel kořullar	
Çalıřtırma sıcaklıđı	+10 – +40 °C
Atmosferik nem	15% – 80%

**Tekrarlanabilirlik**, 10 yüklemenin standart sapması olarak ifade edilir.

**Bađıl nem** - yođuşmasız kořullar altında.

**Stabilizasyon süresi** - optimum ortam kořulları altında.

\* Wi-Fi® is a registered trademark of Wi-Fi® Alliance.



Additional fee for verification



## Aksesuarlar (Additional Fee)

AP2-4 Güç döngüsü çıkıřı  
RS 232 Kablolar (Teraziler - Yazıcı)  
Transponder kart okuyucular  
RS 232 Kabloları (Teraziler - ZEBRA Yazıcı)  
Ađ kabloları (Teraziler - Ethernet)

Etiket Yazıcısı  
Tartım terminalleri için tutucular  
Klavye  
Fiř yazıcı  
USB Kablolar (terazi-Epson yazıcı)

Display  
RS 232, RS 485 Kabloları  
Giriş/Çıkış kabloları  
Barkod okuyucu

Modülleri ek platformları  
Ek modüller  
RS 232 – USB Dönüştürücü

## Yazılım (Additional Fee)

- E2R Tartım [WX-010-0099]
- Audit Trail Reader [WX-010-0186]
- RADWAG Remote Desktop [WX-010-0107]
- Terazi Editörü - EWAG 2.1 [WX-010-0173]
- RAD Key [WX-010-0005]
- Etiket Editörü R02 [WX-010-0094]
- R-Lab [WX-010-0080]
- RADWAG Development Studio [WX-010-0104]

## Cihaz boyutları G x D x Y



HY10.16 - 32.HRP.H

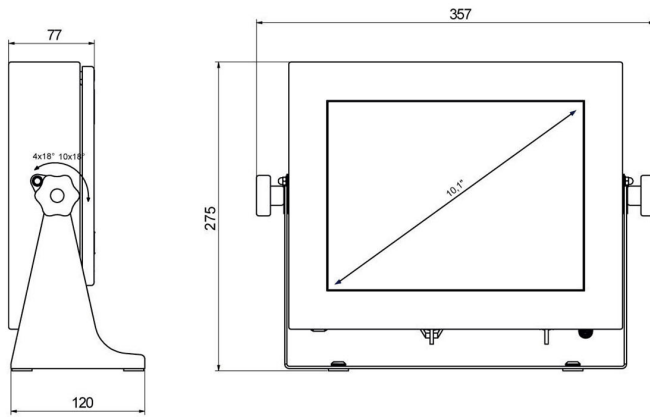

PUE HY10

Scale type	A1	A2	H
HY10.(16-32).HRP.H	360	280	180±5
HY10.(62-150).HRP.H	500	400	180±5
HY10.150.2.HRP.H	500	500	180±5
HY10.(150.1-300).HRP.H	800	600	180±5
HY10.(300.1-1100).HRP.H	1000	800	180±5
HY10.(2000).HRP.H	1250	1000	180±5

Dimensions in mm