



More information on the website  
[mirror.radwag.com/es/info,w1,27M](http://mirror.radwag.com/es/info,w1,27M)

# Báscula impermeable H315.60/150.HR3.M

WP-124-1063





The drawings, photos and graphics used are for illustrative purposes only.

## Funciones

 Control más/menos

 Desviaciones porcentuales

 Resumiendo pesajes

 Contar piezas

 Batería interna

 Cierre de la indicación máxima

 Medición en Newtons

 Pesar animales

## Datos técnicos

| Parámetros metrológicos      |                                 |
|------------------------------|---------------------------------|
| Maxima capacidad [Max]       | 60 / 150 kg                     |
| Minima capacidad             | 400 g                           |
| Legibilidad [d]              | 20 / 50 g                       |
| División de legalización [e] | 20 / 50 g                       |
| Rango de tara                | -150 kg                         |
| Clase OIML                   | III                             |
| Parámetros físicos           |                                 |
| Pantalla                     | 4,3" LCD (con retroiluminación) |

| Parámetros físicos                   |   |
|--------------------------------------|---|
| Dimensión de platillo                | 410x410 mm  |
| Dimensiones de embalaje An x Pr x Al | 510x510x270 mm  |
| Masa neta                            | 15,5 kg   |
| Masa bruta                           | 17,3 kg   |
| Construcción                         |   |
| Grado de protección                  | IP 66 / 67 / 69 construcción, IP 68 / 69 extensómetro, IP 66 / 67 / 69 terminal |
| Construcción                         | Acero inoxidable AISI316  |
| Interface de comunicación            |   |
| Conectividad                         | RS232, USB  |
| Interfaces opcionales                | RS232 o RS485 o 4IN/4OUT o Ethernet o entradas analógica 4-20 mA                |
| Parámetros electricos                |   |
| Alimentacion                         | 100 – 240 V AC 50/60 Hz   |
| Corriente de alimentación adicional  | batería interna   |
| Horas de trabajo con baterias        | max 7h  |
| Condiciones ambientales              |   |
| Temperatura de trabajo               | -10 – +40 °C  |
| Temperatura de almacenamiento        | -25 – +70 °C  |
| Humedad relativa de aire             | 10% – 85% RH sin condensación   |



Additional fee for verification



## Accesorios (Additional Fee)

Cables RS 232 (Bascula a Impresora)  
Mesas antivibratil  
Salidas del bucle de corriente AP2-3  
Pantallas  
Cables de corriente (Bascula a Ethernet)  
Cables RS 232, RS 485  
Adaptadores de corriente

Convertidor RS 232 a Ethernet  
Adaptadores USB  
Impresoras de recibos  
Cable USB (Bascula a Impresora)  
Soportes, brazos  
Convertidor RS 232 a USB  
Soportes con transportadores con rollos

## Programas (Additional Fee)

• RAD Key [WX-010-0005]  
• Editor de Balanzas 2.1 [WX-010-0173]

• R-LAB [WX-010-0080]

## Dimensiones de aparato An x Pr x Al

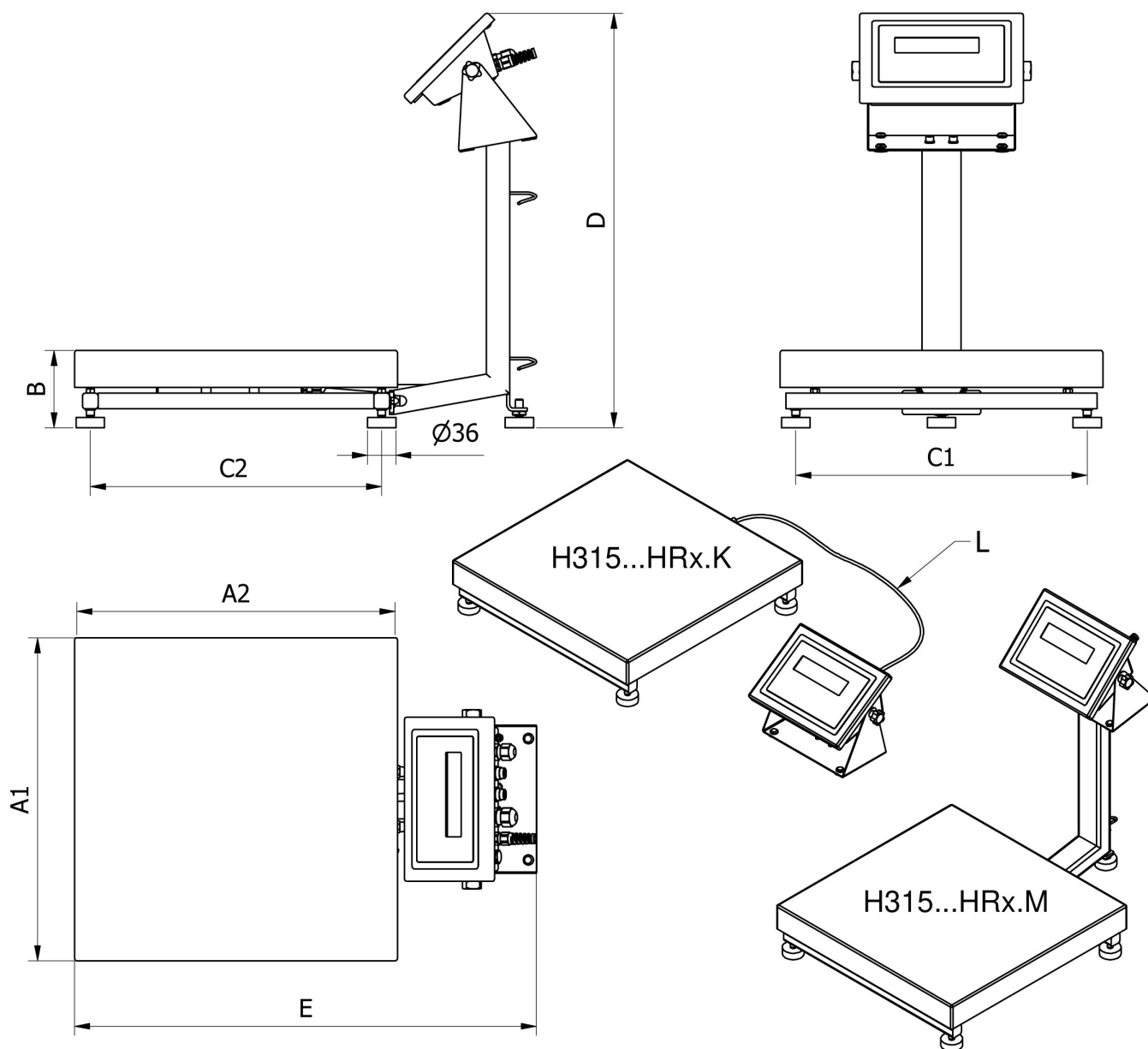

|                |           | A1  | A2  | B       | C1  | C2  | D    | E    | L    |
|----------------|-----------|-----|-----|---------|-----|-----|------|------|------|
| H315...HR2.M   | 250 x 300 | 246 | 306 | 104 ± 3 | 208 | 268 | ~525 | ~483 |      |
| H315...HR2.K   | 250 x 300 | 246 | 306 | 104 ± 3 | 208 | 268 | -    | -    | 1,5m |
| H315...HR3.M   | 410 x 410 | 410 | 410 | 98 ± 2  | 370 | 370 | ~525 | ~587 |      |
| H315...HR3.K   | 410 x 410 | 410 | 410 | 98 ± 2  | 370 | 370 | -    | -    | 2,5m |
| H315...HR4.M   | 500 x 500 | 497 | 497 | 155 ± 5 | 400 | 400 | ~767 | ~650 |      |
| H315...HR4.K   | 500 x 500 | 497 | 497 | 155 ± 5 | 400 | 400 | -    | -    | 2,5m |
| H315...HR3/5.M | 400 x 600 | 597 | 397 | 155 ± 5 | 500 | 300 | ~767 | ~550 |      |
| H315...HR3/5.K | 400 x 600 | 597 | 397 | 155 ± 5 | 500 | 300 | -    | -    | 2,5m |
| H315...HR5.M   | 600 x 600 | 597 | 597 | 155 ± 5 | 500 | 500 | ~767 | ~750 |      |
| H315...HR5.K   | 600 x 600 | 597 | 597 | 155 ± 5 | 500 | 500 | -    | -    | 2,5m |