



More information on the website
mirror.radwag.com/en/info,w1,168

HX7.4N.300/600.H2 Multifunctional Stainless Steel Ramp Scale

WP-227-1009



The drawings, photos and graphics used are for illustrative purposes only.

Functions



Dosing



Percent Weighing



Parts counting



Formulation



Replaceable unit



ALIBI Memory

Datasheet

Metrological parameters	
Maximum capacity [Max]	300 / 600 kg
Minimum load	2 kg
Readability [d]	100 / 200 g
Verification unit [e]	100 / 200 g
Tare range	-600 kg
OIML Class	III
Physical parameters	
Display	7" graphic colour

Physical parameters	
Cable length	3 m
Weighing pan dimensions	1100×1200 mm
Packaging dimensions W x D x H	1500×1300×600 mm
Net weight	149.7 kg
Gross weight	186.3 kg
Construction	
Protection class	IP 66 / 69 construction, IP 66 / 67 terminal
Keypad	membrane
Construction	Stainless steel AISI304
Communication interface	
Communication interface	RS232, USB-A, 4IN, 4OUT, Ethernet, Modbus TCP/IP
Optional interfaces	USB (M12 4P), RS485, RS232, Profibus (Dp SLAVE), PROFINET (RJ45), EtherNet/IP (RJ45), 12 IN / 12 OUT, 4-20mA, 0-10V
Electrical parameters	
Power supply	100 – 240 V AC 50/60 Hz
Power consumption max.	25 W
Optional power supply	12 – 24 V DC
Environmental conditions	
Operating temperature	-10 – +40 °C
Storage temperature	-10 – +50 °C
Relative humidity	10% – 80% RH no condensation
Indicator	PUE HX7
Number of buttons	22
Features of use	
Max number of platforms	2



Additional fee for verification



Accessories (Additional Fee)

RS 232 cables (scale - printer)
 RS 232 cables (scale - ZEBRA printer)
 Displays
 Power Adapters
 RS 232, RS 485 cables
 USB cable (scale - printer)
 IN/OUT Cables
 Barcode scanners

Label Printers
 Stands, wall mounting kits and mounting brackets
 Keypad, external switches
 USB adapter
 Receipt Printer
 Additional Weighing platforms Module
 RS 232 – USB Converter
 Additional modules

Software (Additional Fee)

- E2R Weighing [WX-010-0099]
- Label Editor R02 [WX-010-0094]
- R-Lab [WX-010-0080]
- RADWAG Development Studio [WX-010-0104]

- RAD Key [WX-010-0005]
- Alibi Reader [WX-010-0114]
- Scale Editor 2.1 [WX-010-0173]

Device dimensions W x D x H

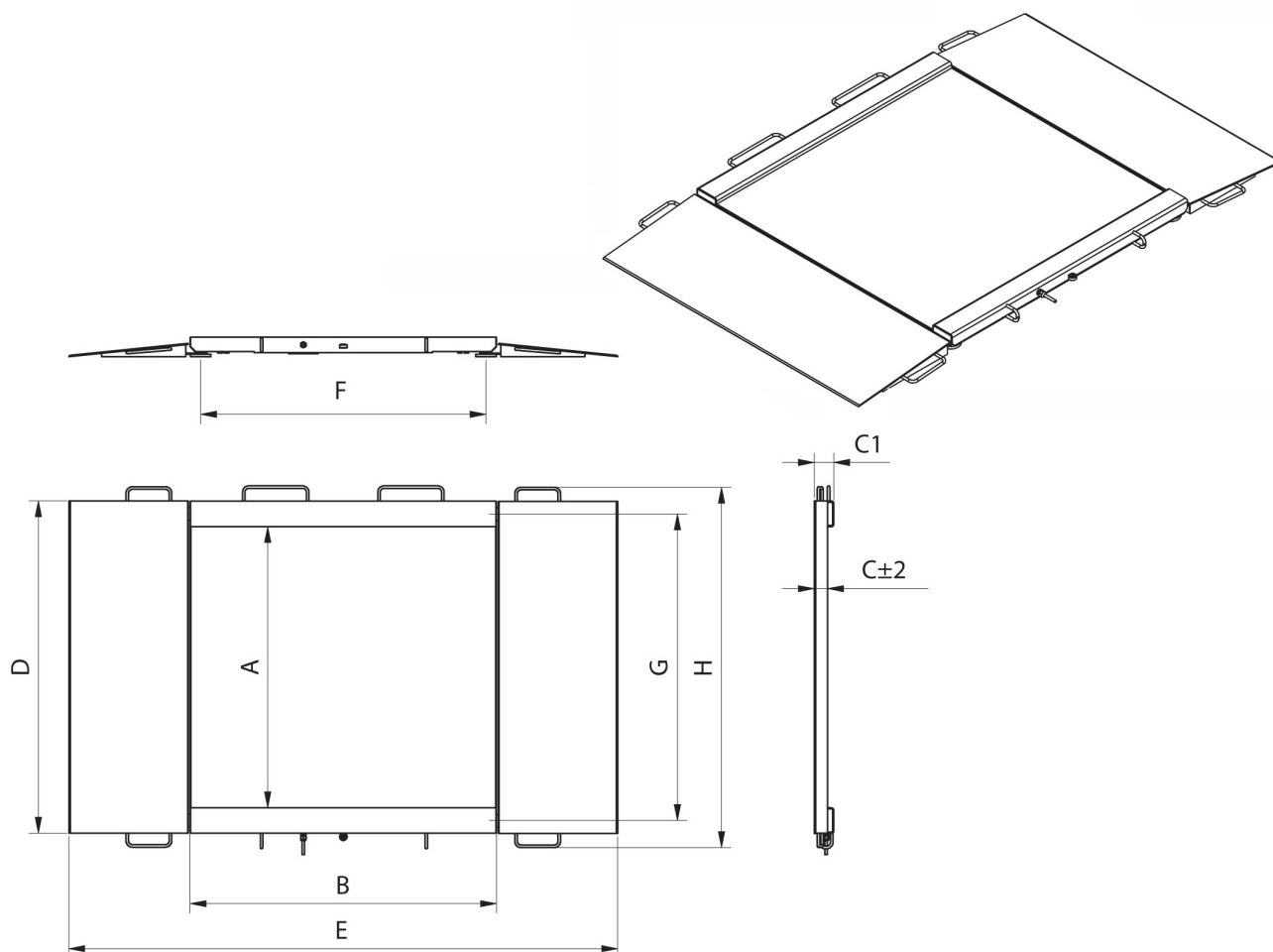

Model	Max	A	B	C	C1	D	E	F	G	H
HX7.4N.150.H1	150 kg	840	860	45,5	76	1040	1710	778	940	1170
HX7.4N.300.H1	300 kg	840	860	45,5	76	1040	1710	778	940	1170
HX7.4N.600.H1	600 kg	840	860	45,5	76	1040	1710	778	940	1170
HX7.4N.150.H2	1500 kg	1100	1200	45,5	76	1300	2050	1118	1200	1430
HX7.4N.300.H2	300 kg	1100	1200	45,5	76	1300	2050	1118	1200	1430
HX7.4N.600.H2	600 kg	1100	1200	45,5	76	1300	2050	1118	1200	1430
HX7.4N.1500.H2	1500 kg	1100	1200	52,5	76	1300	2150	1118	1200	1430
HX7.4N.300.H3	300 kg	1200	1500	45,5	76	1400	2350	1418	1300	1530
HX7.4N.600.H3	600 kg	1200	1500	45,5	76	1400	2350	1418	1300	1530
HX7.4N.1500.H3	1500 kg	1200	1500	52,5	76	1400	2450	1418	1300	1530
HX7.4N.300.H4	300 kg	1500	1500	52,5	76	1700	2450	1418	1600	1830
HX7.4N.600.H4	600 kg	1500	1500	52,5	76	1700	2450	1418	1600	1830
HX7.4N.1500.H4	1500 kg	1500	1500	52,5	76	1700	2450	1418	1600	1830

* dimensions in mm