



More information on the website  
[mirror.radwag.com/br/info,w1,14A](http://mirror.radwag.com/br/info,w1,14A)

# H315.15/30.H2.K Waterproof Scale

WP-124-1014





The drawings, photos and graphics used are for illustrative purposes only.

## Funções

 Plus/Minus Control

 Percent Weighing

 Totalizing

 Parts counting

 Internal battery

 Peak hold

 Newton unit measurement

 Animal weighing

## Ficha Técnica

### Parâmetros metrológicos

Capacidade máxima [máx]	15 / 30 kg
Carga mínima	100 g
Resolução [d]	5 / 10 g
Unidade de verificação [e]	5 / 10 g
Faixa de tara	-30 kg
Classe OIML	III

### Parâmetros físicos

Display	4,3" LCD (retroiluminado)
Comprimento até cabo	1,5 m

Parâmetros físicos	
Dimensões até prato de pesagem	250×300 mm
Dimensões da embalagem L x P x A	560×310×270 mm
Peso líquido	9 kg
Peso bruto	10,3 kg
Construção	
Classe de proteção	IP 66 / 67 construção, IP 66 / 67 / 69 terminal
Interface de comunicação	
Interface de comunicação	RS232, USB
Interfaces opcionais	RS232 ou RS485 ou 4IN/4OUT ou Ethernet ou com saída analógica 4-20 mA
Parâmetros elétricos	
Fonte de alimentação	100 – 240 V AC 50/60 Hz
Fonte de alimentação opcional	bateria interna recarregável
Tempo de operação com baterias	max 7h
Condições ambientais	
Temperatura de operação	-10 – +40 °C
Umidade relativa	10% – 85% RH sem condensação



Additional fee for verification



## Acessórios (Additional Fee)

Unidade de loop de corrente AP2-4  
 Mesa de rolos  
 Mesas antivibração  
 Displays

Conversor RS 232 – Ethernet  
 Impressora de recibos  
 RS 232 – Conversor USB  
 RS 232, RS 485 cabos

## Software (Additional Fee)

• RAD Key [WX-010-0005]

• R-Lab [WX-010-0080]

## Dimensões do dispositivo L x P x A

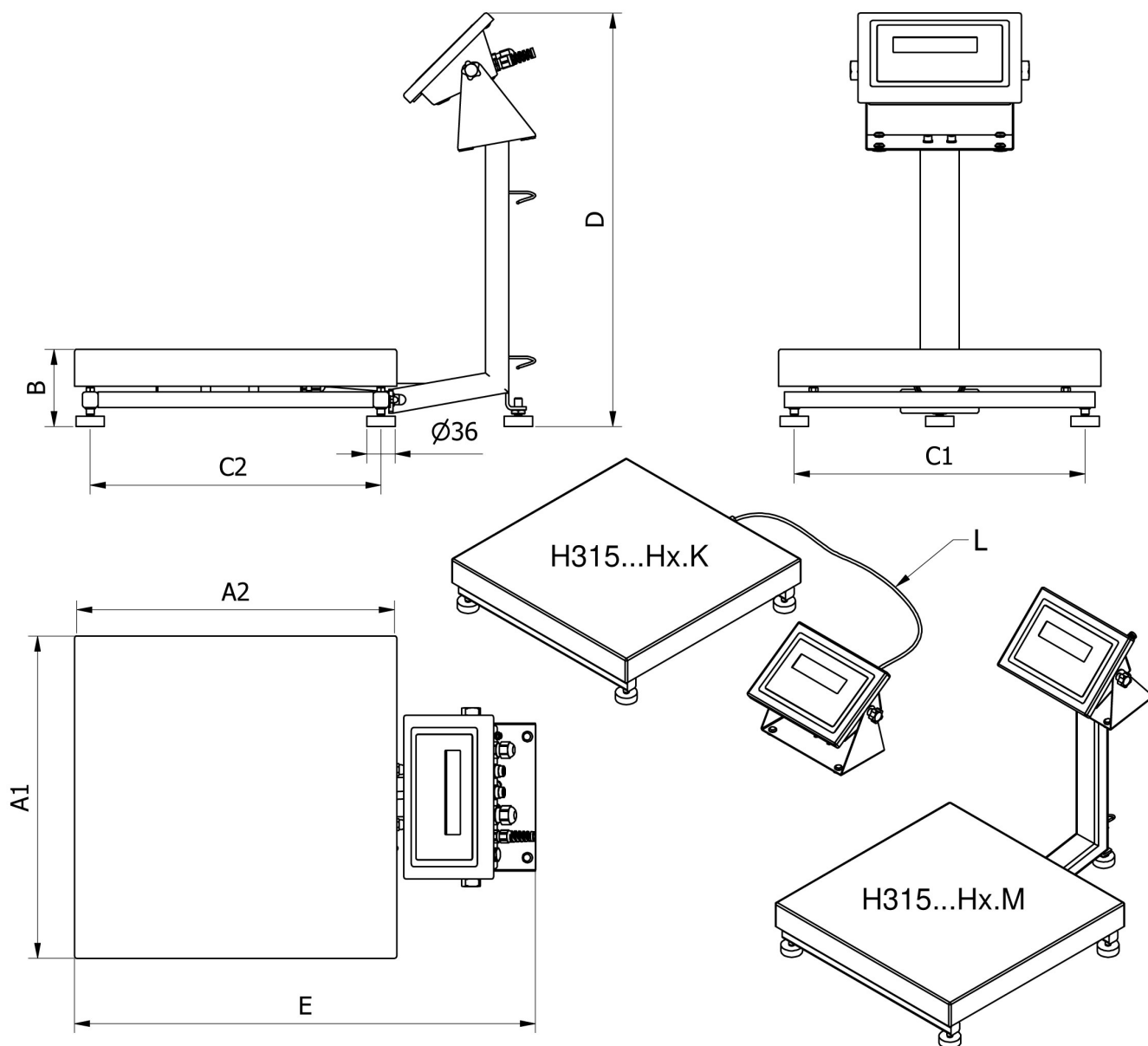

		A1	A2	B	C1	C2	D	E	L
H135...H1.M	150 x 200	152	202	87 ± 3	110	190	~443	~361	
H135...H1.K	150 x 200	152	202	87 ± 3	110	146	-	-	1,5m
H315...H2.M	250 x 300	246	306	104 ± 3	208	268	~525	~483	
H315...H2.K	250 x 300	246	306	104 ± 3	208	268	-	-	1,5m
H315...H3.M	410 x 410	410	410	98 ± 2	370	370	~525	~587	
H315...H3.K	410 x 410	410	410	98 ± 2	370	370	-	-	2,5m
H315...H4.M	500 x 500	497	497	155 ± 5	400	400	~767	~650	
H315...H4.K	500 x 500	497	497	155 ± 5	400	400	-	-	2,5m
H315...H3/5.M	400 x 600	597	397	155 ± 5	500	300	~767	~550	
H315...H3/5.K	400 x 600	597	397	155 ± 5	500	300	-	-	2,5m
H315...H5.M	600 x 600	597	597	155 ± 5	500	500	~767	~750	
H315...H5.K	600 x 600	597	597	155 ± 5	500	500	-	-	2,5m
H315...H6.M	800 x 800	799	799	135 ± 5	720	740	~773	~976	
H315...H6.K	800 x 800	799	799	135 ± 5	720	740	-	-	2,5m