



















More information on the website  
[mirror.radwag.com/en/info,w1,0KW](http://mirror.radwag.com/en/info,w1,0KW)

# WLY 60/120.C2.R.PGC Scale



The drawings, photos and graphics used are for illustrative purposes only.

## Functions

-  Dosing
-  Labelling
-  Plus/Minus Control
-  Percent Weighing
-  Totalizing
-  Parts counting
-  Peak hold
-  Formulation
-  Newton unit measurement
-  Statistics
-  Checkweighing
-  IR sensors
-  Animal weighing
-  Differential weighing
-  Packaged Goods Control
-  ALIBI Memory

## Datasheet

Metrological parameters	
Maximum capacity [Max]	60 / 120 kg
Minimum load	0.5 kg
Readability [d]	10 / 20 g
Verification unit [e]	10 / 20 g
Tare range	-120 kg
Repeatability	10 / 20 g

Metrological parameters	
Linearity	±10 / 20 g
Stabilization time	3 s
Adjustment	external
OIML Class	II
Physical parameters	
Leveling system	manual
Display	5.7" resistive colour touchscreen
Weighing pan dimensions	400×500 mm
Packaging dimensions	720×620×210 mm
Net weight	12.5 kg
Gross weight	15 kg
Construction	
Protection class	IP 43
Communication interface	
Communication interface	2×RS232, 2×USB-A, Ethernet, 4 IN / 4 OUT (digital), Wi-Fi
Electrical parameters	
Power supply	Adapter: 100 – 240V AC 50/60Hz 1A; 15V DC 2.4A Balance: 10 – 28V DC 1A max
Environmental conditions	
Operating temperature	+15 ÷ +30 °C
Storage temperature	-25 - +70 °C
Relative humidity	10% ÷ 85% RH no condensation

\* Wi-Fi® is a registered trademark of Wi-Fi® Alliance.



## Accessories

Transponder card readers  
 Power Adapters  
 RS 232 cables (scale - printer)  
 Cigarette lighter receptacle power supply cables  
 Barcode scanners  
 Under-pan weighing  
 RS 232, RS 485 cables  
 Label Printers  
 Additional modules  
 Displays

IN/OUT Cables  
 Keypad, external switches  
 Stands, wall mounting kits and mounting brackets  
 Receipt Printer  
 F1 Mass Standard - knob weights without adjustment chamber, set  
 AP2-1 Current Loop Unit  
 RS 232, RS 485 cables  
 Additional Weighing platforms Module  
 RS 232 – USB Converter  
 RS 232 cables (scale - printer)

## Software

- E2R Weighing [WX-010-0099]
- E2R Weighing Records [WX-010-0038]
- Audit Trail Reader [WX-010-0186]
- RADWAG Remote Desktop [WX-010-0107]

- E2R PGC [WX-010-0051]
- RAD Key [WX-010-0005]
- Label Editor R02 [WX-010-0094]
- R-Lab [WX-010-0080]

## Device dimensions



F1 version

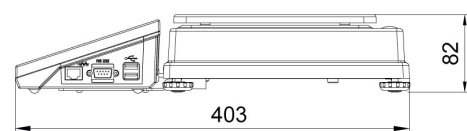

D2 version

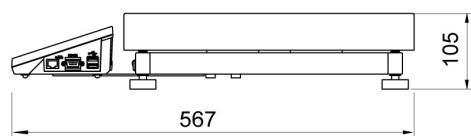
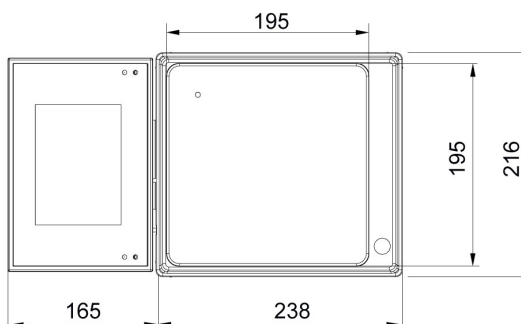

C2 version

