



More information on the website
mirror.radwag.com/tr/info,w1,09D

C32.6.F1.K Çok Fonksiyonlu Terazi

WP-120-0011



The drawings, photos and graphics used are for illustrative purposes only.

Fonksiyonlar



Labelling



Plus/Minus Control



Percent Weighing



Totalizing



Parts counting



Newton unit
measurement



Statistics



IR sensors



GLP Procedures



Replaceable unit



ALIBI Memory

Teknik Veriler

Metrolojik parametreler

Maksimum yük [Max]	6 kg
Minimum yük [Min]	40 g
Okuma için doğruluğu [d]	2 g
Yasallaştırma birimi [e]	2 g
Dara aralığı	-6 kg
Ticari amaçla kullanılmayan terazi için maksimum hassasiyet	0,2 g
OIML sınıfı	III

Fiziksel parametreler	
Display	5" grafik renkli
Kablo uzunluđu	1 m
Tartım kefesi boyutları	300x300 mm
Ambalaj boyutları G x D x Y	570x390x170 mm
Net ağırlık	5,3 kg
Brüt ağırlık	6,1 kg
Konstrüksiyon	
IP Sınıfı	IP 65 konstrüksiyon, IP 43 terminal
Konstrüksiyon	toz kaplı çelik St3S
Tartım kefesi	Paslanmaz çelik AISI304
Haberleşme arayüzler	
Haberleşme arayüzü	2xRS232, USB-A, USB-B, Ethernet, 4 IN / 4 OUT (dijital), Wi-Fi
Elektrik parametreleri	
Güç kaynağı	100 – 240 V AC 50/60 Hz
Maksimum güç tüketimi	10 W
Opsiyonel güç kaynağı	dahili batarya
Batarya ile çalışma süresi	5 saate kadar sürekli çalışma
Çevresel koşullar	
Çalıştırma sıcaklığı	-10 – +40 °C

* Ek ücret karşılığında isteğe bağlı donanım

* Wi-Fi® is a registered trademark of Wi-Fi® Alliance.



Additional fee for verification



Aksesuarlar (Additional Fee)

Display
Güç adaptörü
RS 232 Kablolar (Teraziler - Yazıcı)
Çakmak prizine uygun besleme kabloları
Barkod okuyucu
RS 232, RS 485 Kabloları
Etiket Yazıcısı

Antivibrasyon masaları
Klavye
Tartım terminalleri için tutucular
Ek modüller
Fiş yazıcı
AP2-1 Güç döngüsü çıkışı
Kablolar RS 232 (Teraziler - Yazıcı)

Yazılım (Additional Fee)

- E2R Tartım [WX-010-0099]
- Etiket Editörü R02 [WX-010-0094]
- R-Lab [WX-010-0080]
- RADWAG Development Studio [WX-010-0104]

- RAD Key [WX-010-0005]
- Alibi Okuyucu PC Yazılımı [WX-010-0114]
- Terazi Editörü - EWAG 2.1 [WX-010-0173]

Cihaz boyutları G x D x Y



C32.D2



C32.F1.R



C32.F1.M

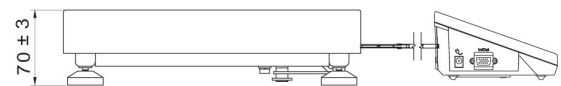

C32.F1.K